

 **Bellucci**
Slim Caffè
Automatic Coffee Machine

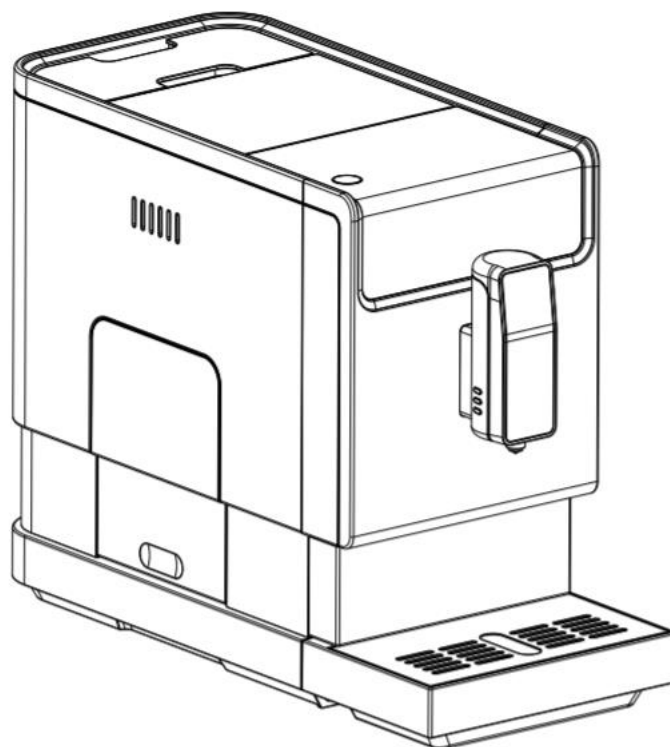

Instruction Manual

IMPORTANT INFORMATION

For safety purpose you should read the instructions carefully before using the appliance for the first time. Save the instructions for future reference.

The appliance is designed for domestic use and may only be operated in accordance with these instructions for use.

Always handle with care and warn other users the potential danger.

These instructions shall also be available in an alternative format, e.g. on a website.

DANGER: Misuse of the appliance can cause injury!

DO's

1. Check the mains voltage stated on the rating plate corresponds to the local electricity supply.
2. Unwind and straighten the power cord before using the appliance.
3. Place the appliance on a firm and steady surface.
4. The appliance must be used and rested on a stable surface.
5. Disconnect the appliance from mains supply outlet under the following conditions:
 - a. Before the water tank is filled with water
 - b. Before removing any parts from the appliance or refit any parts on the appliance.
 - c. Before cleaning or maintenance
 - d. When the appliance is not working correctly
 - e. After using the appliance
6. Empty the water tank, when the appliance is unused for long period
7. Allow to cool before putting on or taking off parts, and before cleaning the appliance.
8. Always use cold water to make coffee. Warm water or other liquids could cause damage to the coffee maker.
9. If the power cord is damaged, it must be replaced by the manufacturer or its service agent or similarly qualified person in order to avoid any hazard.
10. Use the grinder for grinding coffee bean only.
11. Children shall not be playing with the appliance.
12. Always disconnect the appliance from the supply if it is left unattended and before assembling, disassembling or cleaning.
13. Appliance can be used by persons with reduced physical, sensory or mental capabilities or lack of experience and knowledge if they have been given supervision or instruction by a person concerning use of the appliance in a safe way and understand the hazards involved.
14. This appliance shall not be used by children. Keep the appliance and its cord out of reach of children.
15. This appliance is designed for household use only.

DO NOT's

1. Do not allow children to touch the appliance or the power cord during the operation
2. Do not use an extension power cord set unless competent authority has approved it.
3. Do not leave the appliance unattended, when it is connected to main supply.
4. Do not use the appliance in outdoor environment.
5. Do not use appliance for other than intended use.
6. Do not let cord hang over the edge of table or counter or touch hot surface.
7. Do not use or place the appliance on a wet or hot surface.
8. Do not use the appliance if the drip tray is improperly placed in position.
9. Do not immerse the appliance in water or any liquids.
10. Do not use the appliance when any parts of the appliance are damaged.
11. Do not use the appliance when it is not working properly.
12. Do not unplug the appliance by pulling the power cord.
13. Do not place the cord on a sharp edge of an item.
14. Do not attempt to open the main body or dismantle any parts from the appliance, there is no serviceable part inside.
15. The appliance normally cleans after use and is not intended to be immersed in water for cleaning and the appliance must not be immersed.
16. The use of accessories not included in the box is not recommended. It might be dangerous and should be avoided.
17. Do not place the appliance on or near hot gas or electric burner, or in heated oven.
18. **Do not operate the hot water function continuously for more than one tank of water.**



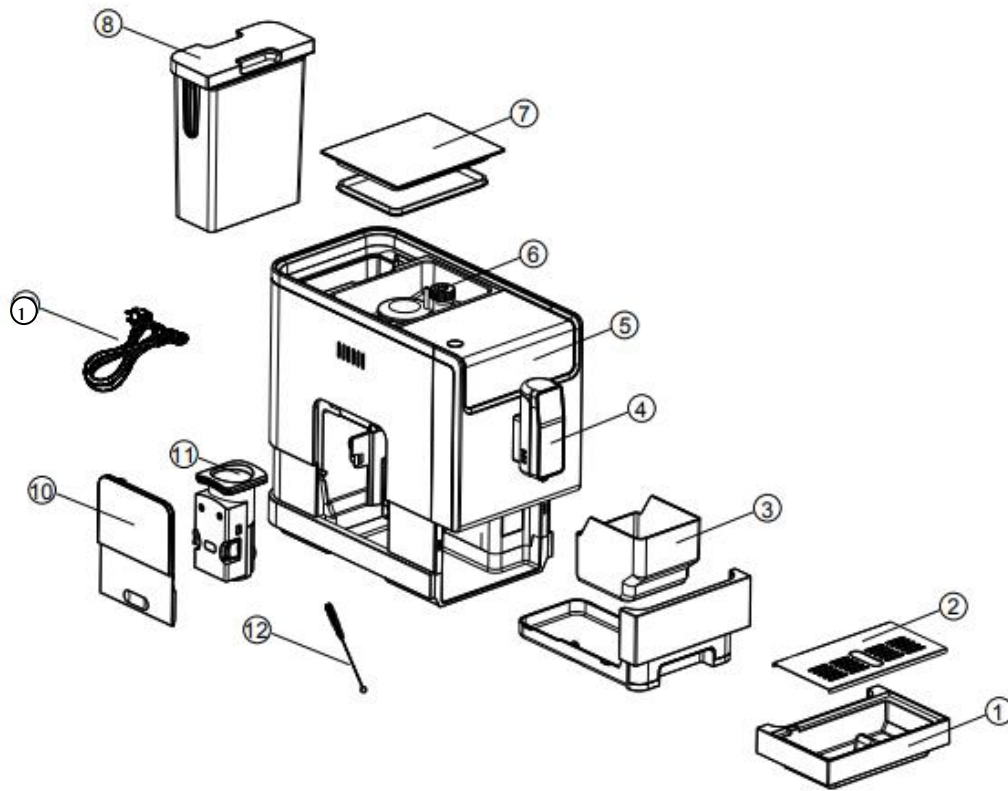





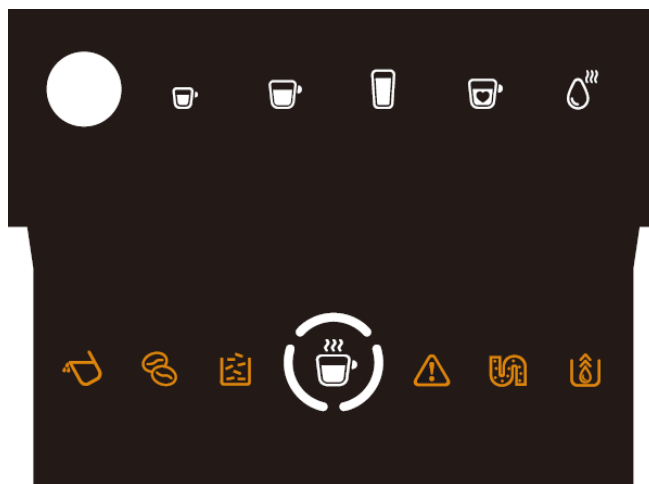
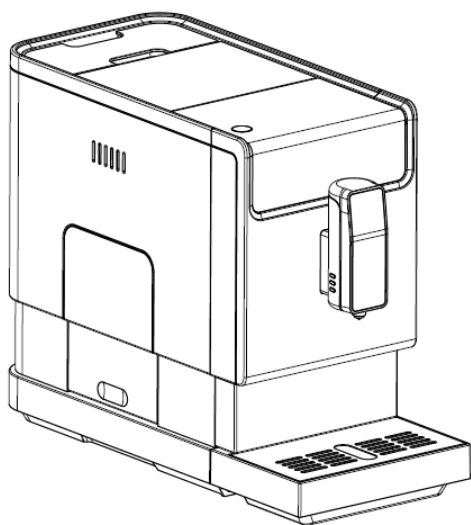



A. GET TO KNOW YOUR AUTOMATIC COFFEE MACHINE
I. GENERAL DESCRIPTION



1. External drip tray	2. Drip tray cover
3. Coffee grounds container	4. Adjustable coffee spout
5. Control panel	6. Coffee bean container
7. Coffee beans container cover	8. Water tank
9. Internal drip tray	10. Service door
11. Brewer	12. Cleanness brush
13. Power cord	

II. CONTROL PANEL & ON/OFF BUTTON



	Flashing: Low water level/ Water tank missing
	Lack of bean
	Lights up stably: coffee grounds container is full Flashing: Internal Drip Tray/coffee grounds container is missing
	Lights up stably: Brewer is missing/ installed improperly Flashing: Service door is opened / installed improperly
	Lights up stably: Requires to do descaling Flashing: Descaling is under process
	Empty System Function is running
	Power ON/OFF Button
	Hot Water Button
	Strong Coffee Button
	Mild Coffee Button
	Americano Button
	Favorite Coffee Button
	Coffee Brewing Indicator

III. ACCESSORY

In the box, three packs of cleaning agents are included for the process of Descaling .

B. MACHINE INSTALLATION

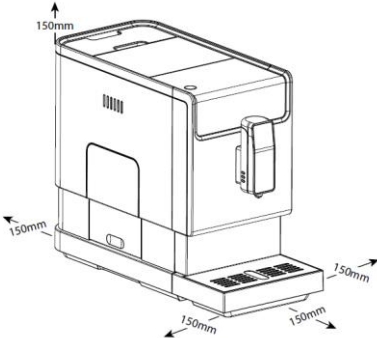
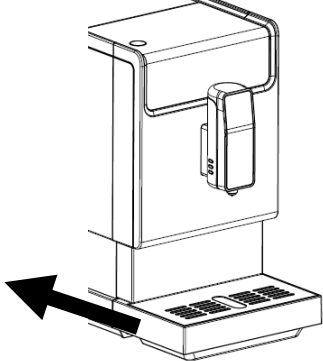
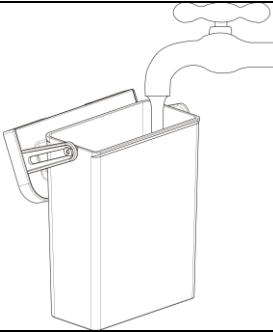
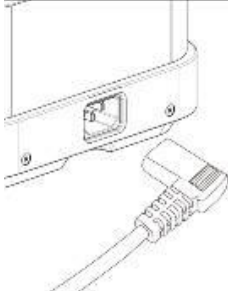

<p>1. Remove any protective films, stickers and any other packing material on the appliance</p>	
<p>2. Choose a safe and stable surface with an easily reachable power supply and allow minimum distance from the sides of the machines .</p>	
<p>3. Insert the external drip tray. Make sure it is inserted correctly.</p>	
<p>4. Fill the water tank with water (see "FILLING THE WATER TANK")</p>	
<p>5. Fill the bean box with coffee bean (SEE "FILLING THE COFFEE BEAN CONATINER")</p>	
<p>6. Unwind and straighten the power cord and insert the plug into the socket located on the back of the machine. Insert the other end of the power cord into a wall socket with suitable power voltage.</p>	

C. Daily Operation

I. MAKING YOUR COFFEE

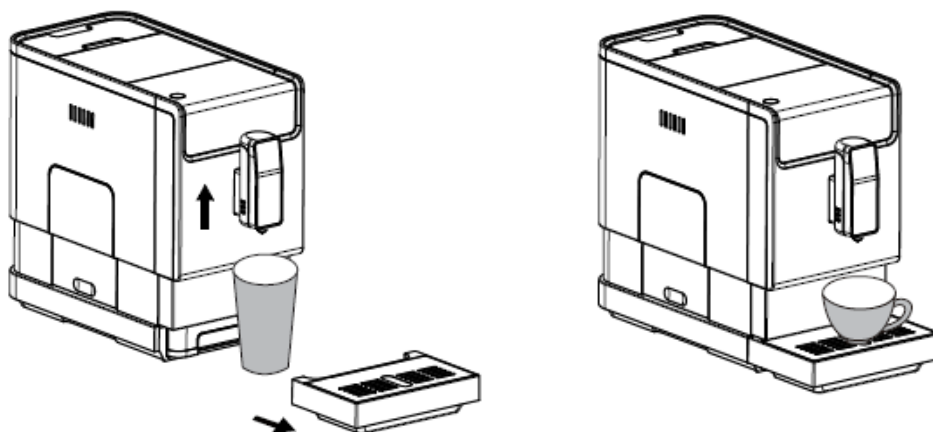
1. Switch on the appliance by pressing the power on/off button and make sure the drip tray is under the coffee spout and the water tank is filled with water inside. The appliance will perform auto-rinsing for a small cup of water, you can stop it by pressing Hot Water Button.
2. The appliance is then in the standby condition.
3. Place a cup under the coffee spout and adjust the height of the spout to fit the cup. Depending on the size of the cup (too tall or too wide) you can remove the drip tray or adjust the position of the drip tray as below:



4. Depending on the taste of coffee you would like to have, press strong coffee button  or mild coffee button .

5. The coffee button being pressed will light up, brewing coffee indicator and illumination under spout will light up to indicate that the appliance is preparing the cup of coffee. You can stop dispensing coffee by pressing the button again.
6. When the appliance is back to standby condition, the coffee is ready to serve.

Tip1: the strong coffee button with higher coffee intensity which recommend for espresso, while both coffee button volumes can be adjusted (see page 12 section D further setting)

Tip2: The auto rinsing will not activate if the appliance was just switch off for a short moment. You can deactivate this function by following the steps and activate this function by same way.

Step1) remove the service door

Step2) press On/Off button until you hear a bip.

Note: Press the hot water button (see page 9 section IV) to clean inner parts of the coffee maker before first use.

II. FILLING THE WATER TANK

When  is flashing, the water tank is in low water level and requires filling the water tank.

1. Lift the water tank by using the lid as the handle

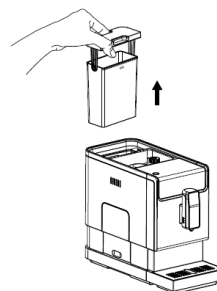

2. Rinse the water tank with fresh water and then fill the tank to the "Max" level and place it back into the machine. Make sure it is fully inserted.

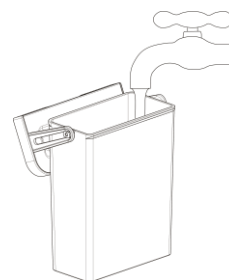

Note: To prevent overflow of water from the water tank, do not add water directly into the appliance with another container

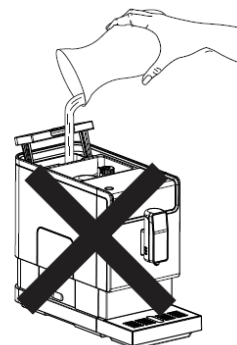

IMPORTANT: Never fill the water tank with warm, hot, sparkling water or any other liquid which might damage the water tank and the machine

III. FILLING THE BEAN CONTAINER

When  is flashing, the appliance needs to be filled with coffee bean:

1. Remove the bean container lid
2. Slowly pour in the coffee beans.
3. Install back the container lid.

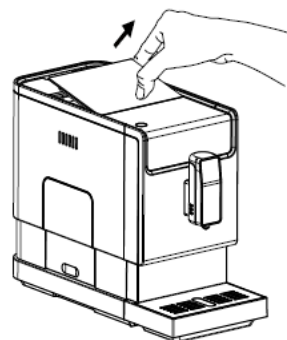

IMPORTANT: Fill the coffee bean container with coffee beans only. Grounded coffee, instant coffee, caramelized coffee and any other objects may damage the machine

IV. HOT WATER

The appliance can dispense hot water by simply pressing the hot water button. The hot water button light up, brewing coffee indicator and illumination under spout will lights up indicates that the appliance is heating up the water. When the hot water button and the illumination turn off, the water is ready to serve.

V. FAVOURITE FUNCTION

You can use the favourite function to memorize your desired volume of mild coffee, strong coffee and Americano coffee which is not easy to be adjusted by other people

1. Set up the favourite coffee setting

a) Press and hold the favourite button  for 2 second, then the mild coffee, strong coffee, Americano coffee and hot water button will flash and you can select any one to memorize the volume.



b) When you select either strong espresso, mild espresso, Americano coffee or hot water, you will see the drinks come out, and then you can press and hold to keep dispensing the drinks and stop it by release the button. After that the volume will be memorized.



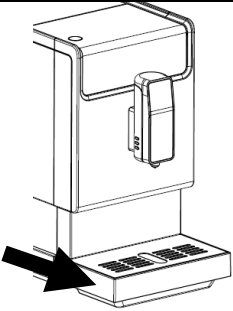
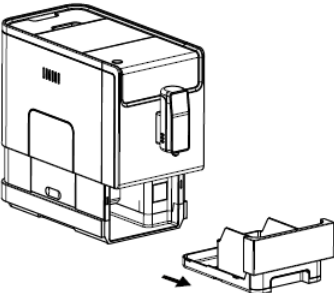

2. Using the favourite function

a) Press the favorite function button , the memorized favorite drinks will come out.

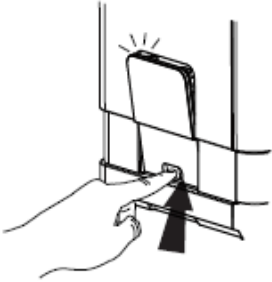
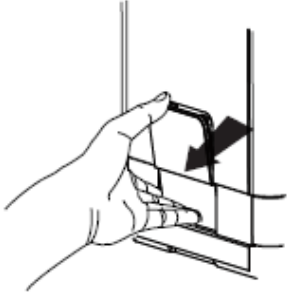
VI. DAILY CLEANING OF THE APPLIANCE

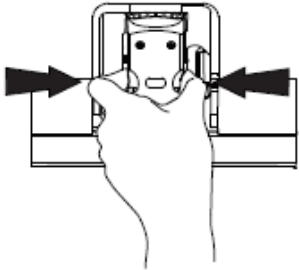
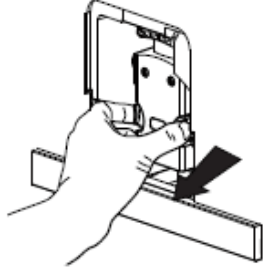
Timely cleaning and maintenance of the appliance is very important in prolonging the life of the appliance.

<p>1. Remove the external drip tray.</p>	
<p>2. Empty the water inside the drip tray in the sink and wash it with fresh water. Dry it afterwards.</p>	
<p>3. Slides open the internal drip tray and the coffee grounds container.</p>	
<p>4. Empty the coffee grounds container and wash it with fresh water. Dry it afterwards.</p> <p>Note: When  lights up, the coffee grounds container needs to be empty.</p>	
<p>5. Pull down the service door.</p>	
<p>6. Remove the service door.</p>	

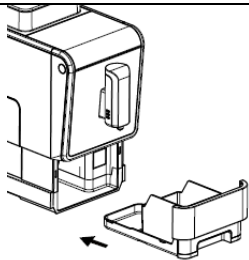
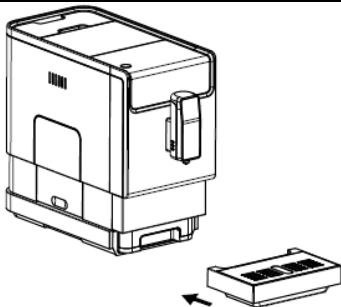
<p>7. Press the release knob.</p>	
<p>8. Remove the brewer.</p>	
<p>9. Wash the brewer with fresh water. Dry the brewer afterwards.</p>	
<p>10. Insert back the brewer to its original position and install back the service door to its original position.</p> <p>Note: When  lights up stably, it indicate that the brewer is missing / installed improperly.</p> <p>When  is flashing, it indicates that the service door is missing/ installed improperly.</p>	
<p>11. Place the coffee grounds container on the internal drip tray and insert back into it original position.</p> <p>Note: When  is flashing, the coffee grounds container is missing</p>	
<p>12. Place the external drip tray at its original position</p>	

VII. Turning Off the machine

Switch off the appliance by pressing the power on/off button.

VIII. Auto-Shut off

The Appliance is equipped with auto-shut off. Depending on the mode you have selected the appliance will have different auto-shut off timing (SEE “D. Further Setting - III Mode Selection”).

D. FURTHER SETTING

I. ADJUSTING THE VOLUME OF YOUR COFFEE/HOT WATER

You can memorize your desired volume of coffee for strong espresso, mild espresso, Americano and also the hot water from 25ml to 250ml.

1. When making your coffee (either strong coffee or mild coffee or Americano) or dispensing hot water, press and hold the button you selected. The appliance will continue to make the cup of coffee or hot water
2. When the volume of coffee meets your desired volume, release the button. Two beep sounds will be heard indicates that the volume of coffee is being memorized.

II. GRINDING ADJUSTMENT

You can adjust the grinder to suit the taste of your coffee by turning adjuster knob in the bean container:

1. When the grinder is grinding the coffee bean during making the coffee, you can turn the adjust knob to do the adjustment

(CAUTION: Never do the grinding adjustment when the grinder is not operating. It may damage the grinder.)

2. The dots on the adjuster knob indicate the fineness of the grind.

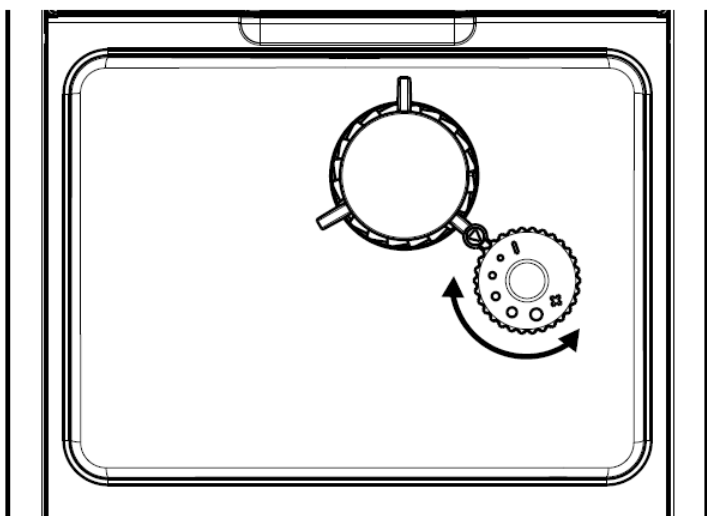





MODE SELECTION

The machine has three different settings: default setting, ECO mode and speed mode. In ECO mode, the appliance helps to save more energy. In speed mode, the user can make their coffee faster than in default setting.

	ECO Mode	Speed Mode	Default Setting
Illumination Light	No	Yes	Yes
Pre-brewing*	Yes	No	Yes
Auto shut off time	10mins	30mins	20mins
Cup Volume memory	Yes	Yes	Yes

*Note: The pre-brewing function moistens the grounded beans in the brewer with a small amount of water before full extraction. This expands the coffee grounds to build up a greater pressure in the brewer which help extraction of all the oils and full flavor from the grounded beans.

- When the machine is in standby condition, press and holds the  for 5 seconds.
- The following button will have the following indications in different settings:











	Hot water button 	Strong coffee button 	Mild coffee button 
In ECO Mode	Lights on	Flashing	Flashing
In Speed Mode	Flashing	Lights ON	Flashing
In Default Setting	Flashing	Flashing	Lights on

- Press the hot water button for ECO mode, strong coffee button for speed mode and mild coffee button for default setting. Two beep sound will be heard indicates that the mode is being selected. (Note: If you are pressing the relative lighted on button for each mode, the machine will not respond).
- If you would like to remain the setting unchanged, press  again or wait for 5 seconds for the machine to return to the standby condition.

E. CLEANING & MAINTENANCE

I. DESCALING





When  is flashing, it indicates that the appliance needs to undergo descaling. The appliance will remain in the best condition if this function is performed at least once a month or more regularly depending on the hardness of water used. It is also suggested that to

1. Fully fill the water tank.
2. Add one pack of cleaning agent included in the box to the water tank.
IMPORTANT: Do not use vinegar or other cleaning agent to do descaling of this appliance. The cleaning agent might damage the appliance.
3. Plug in the appliance.
4. Place a sufficient large container under the coffee spout.
5. In standby condition, press and hold  and strong coffee button  for 5 seconds. A beep sound will be heard with  and strong coffee button  will be flashing.
6. Press strong coffee button  to confirm undergoing the Descaling process. To resume back to the standby condition, press .
7.  will be flashing indicates that the appliance is undergoing the descaling process. **(Caution: Keep skin/body away from the hot water.)**
8. When all the water in the water tank is being dispensed out,  and strong coffee button  will be flashing. Remove all the remaining solution in the water tank and fill the tank with normal tap water to the “max” position. When water is filled into the water tank,  will go off. Then the appliance will continue the descaling process, the appliance will brew half of water tank first and then waiting for around 1min, after that will brew the outstanding water from the water tank.
9. When the descaling process is completed, **the appliance will switch off automatically.**

Note: To ensure the descaling process can be completed, please be patient during the process and make sure the appliance switches off automatically

II. EMPTY SYSTEM FUNCTION





The empty system function is recommended to be used before long period of non-use, frost protection and before taking to repair agent.

1. In standby condition, press and hold the  and mild coffee button  together for 5 seconds.
2.  will then be flashing.
3. Remove the water tank from the appliance.  will light up stably indicates that the empty system is under process. You can press  before removing the water tank to resume back to the standby condition.
4. When the empty system function is completed, the appliance will switch off automatically

Important: After performing EMPTY SYSTEM FUNCTION; press the hot water button until water come out from spout when the coffee maker is reused again.

III. MANUAL RINSING

You can perform a manual rinsing cycle to clean the coffee spout after use. It is also suggested to perform a manual rinsing if the appliance has not been used for a long period of time.

1. In standby condition, press and hold the  and hot water button  together.
2. The hot water button , strong coffee button  and mild coffee button  will then goes off. The coffee spout will then dispense a small amount of water which is used for the rinsing.

Danger: Water comes out of the coffee spout is hot and is collected in the drip tray underneath. Avoid contact with splashes of water.

3. After rinsing, the appliance will return to the standby condition.

IV. CLEANING THE APPLIANCE

1. Disconnect the power cord from the mains supply outlet.
2. Pour away all the water in the internal and external drip tray
3. Use a damp cloth or non-scratching cleaner to clean the water stains on the appliance.

IMPORTANT: Never use any abrasive, vinegar or descaling agents not included in the box to clean the appliance.

V. Cleaning coffee powder outlet

Coffee powder may stick on the wall of powder outlet for appliance after used a long period of time. It is suggested to clean the outlet by following steps to ensure that coffee powder can come to brewer.

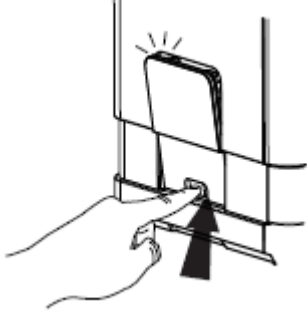
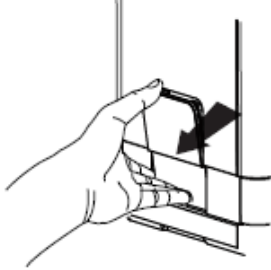
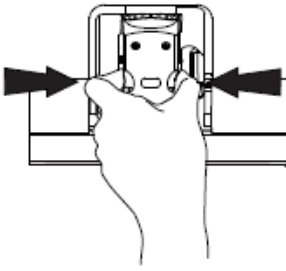
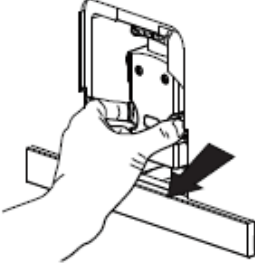
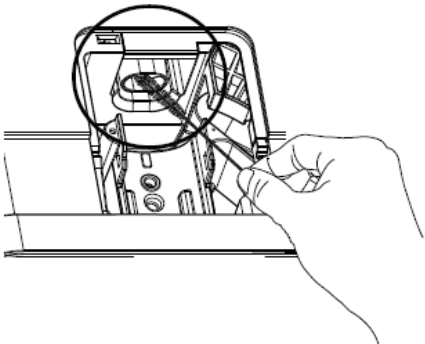
1. Push the service door recess area	
2. Take out the service door	
3. Press the release knob of brewer	
4. Take the brewer out	
5. Use Cleanness Brush to clean the powder outlet	

TROUBLESHOOTING

PROBLEM	CAUSE	SOLUTION
The appliance does not work.	The appliance is not connected to the mains supply.	- Plug in and press the on/off switch. - Check the cable and the plug
No or delayed response in several trials of pressing on function key on the panel	- Appliance is under an electromagnetic interference - Dirt over the panel	- Unplug the appliance. Restart after few minutes - Clean the panel with the cloth provided
The coffee is not hot enough.	- The cups have not been preheated. - The brewing unit is too cold.	-Warm the cups -Rinse the appliance at least 3 times before making the coffee.
The coffee cannot come out from spout.	Empty system function maybe used before.	Press the hot water button until water can come out from spout.
The first cup of coffee is poor quality.	The first run of grinder does not pour sufficient quantity coffee power into the brewing unit.	Throw the coffee away. The other coffees will always be of good quality.
Coffee has no cream.	- Coffee bean is not fresh.	Change or use appropriate brand of coffee bean.
The touch buttons are not sensitive	Not pressing the touch button from the front direction of the appliance	Press the lower bottom part of the touch button icon from the front direction of the appliance.
The appliance takes too long time to warm up.	Excessive scale has built up.	Descale the appliance.
The water tank is removed / the water level is very low in the water tank but indicator have no alert.	The area near the water tank connector is wet.	Wipe the water around the water tank connector
Internal drip tray is filled with a lot of water.	Coffee powder too fine which block the water to come out.	Adjust the coffee fineness to bigger dot during grinder operation.
Coffee is delivered too slowly or a drop at a time.	Coffee powder too fine which block the water to come out.	Adjust the coffee fineness to bigger dot during grinder operation.
Lack of bean indicator flashes but there is still a lot of coffee bean inside the container.	Internal coffee powder outlet is blocked.	To follow the steps of section E (V. Cleaning coffee powder outlet).